

Title: Determining the Prevalence and Antimicrobial Susceptibility of *Salmonella* Serovars Isolated from U.S. Retail Ground Pork - NPB #12-170

Investigators:

Texas Tech University
Dr. J. Chance Brooks
Dr. Guy H. Loneragan
Dr. Mindy M. Brashears
Rand Broadway

Ohio State University
Dr. Thomas E. Wittum

Date Submitted: September 9, 2014

Industry Summary

Salmonella is a foodborne pathogen that may be associated with meat products. The goal of this project was to determine the prevalence of *Salmonella* in ground pork at retail, and to evaluate factors that may be associated with its prevalence. Because ground pork at retail can be regulated by two separate governing bodies, the authors wanted to measure *Salmonella* prevalence in case-ready packages versus store-ground pork using USDA and FDA *Salmonella* isolation protocols. Finally, the *Salmonella* isolated from the ground pork was serotyped and evaluated for antimicrobial resistance using 15 antibiotics.

Ground pork was collected from grocery stores, supermarkets, and retail establishments that sold fresh meat. Packages were collected from 12 cities in 4 different regions of the U.S. (South, East, West, and Central/Midwest) during 3 seasons (Fall, Winter/Spring, and Summer). Approximately one-half of the packages collected in each city were ground and packaged off-site

These research results were submitted in fulfillment of checkoff-funded research projects. This report is published directly as submitted by the project's principal investigator. This report has not been peer-reviewed.

For more information contact:

National Pork Board • PO Box 9114 • Des Moines, IA 50306 USA • 800-456-7675 • Fax: 515-223-2646 • pork.org

(referred to as “case-ready”) and the other half were ground on-site (referred to as “store-ground”). Packages were tested for *Salmonella* using USDA-FSIS and FDA *Salmonella* isolation protocols, as well as genomic evaluation. *Salmonella* isolates from ground pork were additionally evaluated for antimicrobial resistance using 15 antibiotics. Finally, all *Salmonella* isolates were serotyped.

Overall, 1.39% of ground-pork packages were positive for *Salmonella* (12 of 865 packages). There was no difference in *Salmonella* prevalence between case-ready and store-ground pork or between package types (overwrap, chub, MAP, or other). More *Salmonella* was isolated during the Fall season than any other season, and there was a tendency for increased prevalence in the East region. The USDA-FSIS method was a more effective method to isolate *Salmonella* compared to the FDA isolation protocol. None of the isolates were resistant to antibiotics used to treat *Salmonella* infections, such as extended spectrum cephalosporins or fluoroquinolones. Six different serotypes were isolated, and only two packages contained multiple *Salmonella* serotypes.

The results of this study indicate the observed prevalence of *Salmonella* in ground pork products was low. Moreover, a clear majority of the *Salmonella* serotypes were broadly susceptible to the antibiotics tested and none of the serotypes were resistant to critically important antibiotics used in human medicine. Finally, these results indicate the pork industry should continue to utilize technologies and practices to reduce pathogens in pork products.

For additional information, please contact Dr. Chance Brooks at Texas Tech University, Department of Animal and Food Sciences, chance.brooks@ttu.edu

Keywords: pork, *Salmonella*, prevalence, retail, resistance

Abstract

Salmonella is a foodborne pathogen that may be associated with meat products and can cause disease or death in humans. The first objective of this study was to determine the overall prevalence of *Salmonella* in ground pork in stores in the United States over three seasons and four regions. Both case-ready and store-ground packages were obtained throughout the study. The package types collected were overwrap, chub, modified atmosphere packaging (MAP) and other. Because these package types represent different production systems and are subject to different microbiological government regulation and testing methodologies, both USDA-FSIS and FDA *Salmonella* isolation protocols were used. Another objective of the study was to determine the serotypes and antimicrobial resistance profiles of the isolates found. Ground pork aliquots were subjected to real-time PCR isolation. Recovered isolates were then serotyped and minimum inhibitory concentration analysis (MIC) to 15 antimicrobial compounds was determined using micro-broth dilution in accordance with the national antimicrobial resistance monitoring system (NARMS). The overall prevalence of *Salmonella* in ground pork from the 865 samples collected was 1.39%. Prevalence was not affected by package type ($P = 0.29$) or grind location (case-ready vs. store-ground; $P = 0.17$). Season affected *Salmonella* prevalence ($P = 0.05$) with most isolates found during the fall season, and there was a tendency for region to affect *Salmonella* prevalence ($P = 0.07$). The USDA *Salmonella* isolation method was more effective at recovering isolates from packages ($P = 0.01$) in comparison to the FDA methodology and yielded a Kappa statistic of 0.26 as a measure of agreement. The serotypes isolated included: Infantis, 4,5,12:i:-, Brandenburg, Typhimurium var 5-, Seftenberg, and Johannesburg with only 2 packages containing multiple serotypes. There were no isolates resistant to antibiotics used to treat *Salmonella* infections including extended spectrum cephalosporins or fluoroquinolones. Overall, the prevalence of retail ground pork in the U.S. retail market is low.

Introduction

Salmonella is a commonly reported foodborne pathogen in the United States and throughout the world, and causes gastroenteritis (Botteldoorn et al., 2003). Salmonellosis in humans can be the result of the consumption of multiple animal products including but not limited to *Salmonella*-contaminated beef, pork, and eggs (ICMSF, 1996). *Salmonella* was the most commonly reported foodborne bacterial infection in 2011 (16.42 cases per 100,000 people); thus failing to meet objectives to reduce the incidence of foodborne *Salmonella* illness set forward by the 2010 national health objective (6.8 cases per 100,000 people; CDC, 2010). In 2011, the CDC reported an estimated 1,027,561 foodborne illnesses caused by nontyphoidal *Salmonella* in the U.S. (CDC 2014). Scallan et al. (2011) reported 11% of foodborne illnesses in the U.S. were attributable to *Salmonella*, while 35% of hospitalizations and 28% of deaths from foodborne pathogens involved *Salmonella*. In addition, an estimated 19,336 Americans were hospitalized, and 378 people died from *Salmonella* related foodborne illnesses (CDC, 2014). While *Salmonella* infections may occur via routes other than consumption of animal products, the majority of documented *Salmonella* illnesses in the U.S. are attributed to foodborne contamination. Recent estimates by Scallan et al. (2011) report *Salmonella* to be the bacteria causing the most foodborne illness in the U.S. and the report also suggests that 1 million foodborne illnesses were attributable to nontyphoidal *Salmonella*. A previous study Mead et al. (1999) reported more than 95% of non-Typhi *Salmonella* cases in the United States were associated with food products, and additional investigation in Europe reported 90% of human salmonellosis cases were attributable to food products (Anonymous, 2001). While data has been published in other countries concerning the burden of foodborne illness attributable to *Salmonella* from specific food products such as pork, little data has been collected and analyzed in the United States (Miller et al., 2005).

Just as humans may become ill from *Salmonella* infections, food producing species such as swine may also be impacted by this pathogen. *Salmonella* may cause illness in swine as well as reduce growth, production parameters, and profitability. However, *Salmonella* is a bacterium that is commonly colonized in the gastrointestinal tract of pigs, and this microorganism typically does not affect the health of the pig with the exception of some serotypes (Botteldoorn et al, 2003; Daube et al., 1998). Oosterom et al. (1985) reported 21% of healthy swine presented for harvest in the Netherlands harbored *Salmonella* in their gastrointestinal tract.

Salmonella has been described by Escartin et al, (2000) as a common bacterial contaminant of raw pork capable of producing human illness. Recent estimates suggest that among foodborne illness in the U.S., 9 to 15% of all *Salmonella* infections, and 7.5% of *Salmonella* Enteritidis and Typhimurium infections, are associated with the consumption of pork or pork products (Hald et al., 2004; Pires et al., 2010). According to Lo Fo Wong et al, (2002), pork is regarded as a major source of foodborne *Salmonella* illness. Though the risk of *Salmonella* infection from pork consumption is often considered minimal when compared to *Salmonella* infections stemming from the consumption of other food products (especially poultry), the commonality in strains isolated from pigs and human infection combined with *Salmonella*'s ubiquitous nature in the swine production setting makes the pathogen an area of study for the pork industry.

While much of the emphasis on pork contamination is placed at the carcass level, there are many other points in the production chain where products may be contaminated including fabrication, further processing, and handling at retail (Duffy et al., 2000). The retail environment is one of the final steps in the production process and is situated between conception and consumption where *Salmonella* may be propagated or mitigated. Recently, much attention in

America was placed on retail pork products and food safety. A study conducted by Consumer Reports reported 69% of pork samples were contaminated with *Yersinia enterocolitica* (Bottemiller, 2012). Additionally, the consumer group reported that *E. coli*, *Salmonella*, *Staphylococcus*, and *Listeria* were isolated from the pork samples, and some of these strains were resistant to multiple antibiotics (Bottemiller, 2012).

Concern about antibiotic resistance has recently increased in the U.S., especially with regard to sub-therapeutic antibiotic supplementation to livestock for growth promotion effects. In response to these concerns, the FDA recently issued guidance for industry to eliminate growth promotion claims on antibiotic labels, and rules that veterinarians must oversee the antibiotics given in production agriculture (FDA, 2013). Additionally, the National Antimicrobial Resistance Monitoring System (NARMS) for retail meat products was implemented by the FDA, CDC, and FoodNet to monitor the patterns of resistance in retail meats. These data are used to monitor the burden of resistant bacteria on public health and possibly elucidate connections between resistant bacterial trends, profiles and foodborne illnesses.

Resistance may be in part a product of selection pressure caused via the use of antimicrobials and antibiotics because resistant bacteria are able to survive in an environment in which the antimicrobial compound is present at certain concentrations (White et al., 2001). Antibiotic resistance is also important in food animal production, because the efficacy of antibiotics may be jeopardized in the animal. However, antibiotic resistant bacteria in the animal may contaminate carcass tissues and may ultimately contaminate consumable products found at retail. In a study of ground meats, White et al, (2001) determined that 5% of the isolates recovered were resistant to antibiotics of interest that may be used to treat the illness in humans.

Additionally, Consumer Reports indicated 6 of 8 *Salmonella* isolates exhibited resistance to antibiotics (Bottemiller, 2012).

Objectives

There were two main objectives of this evaluation of *Salmonella* ground pork marketed at retail. The initial goal was to determine the prevalence of *Salmonella* in retail ground pork and to evaluate factors that may be associated with *Salmonella* prevalence. Additionally, the authors wanted to distinguish between *Salmonella* prevalence in case-ready packages versus store-ground pork using USDA and FDA *Salmonella* isolation protocols. The final objective of this study was to determine the serotypes of the *Salmonella* isolates and the antimicrobial resistance profiles of the isolates.

Materials and Methods

Sample Collection

Packages of ground pork (n = 865) were obtained from retailers across the United States over a 12-month period. Pork was obtained from 12 cities within 4 geographical regions within the U.S. (West, South, Central/Midwest, and East; Figure 1). Within the 12-month period, approximately the same number of samples was collected from three different seasons (Fall: September – November, Winter/Spring: January-March, Summer: June-August) to determine if season affected *Salmonella* prevalence of ground pork at retail stores. A total of 24 packages were obtained from each city. Approximately one-half of the packages collected at each location were case-ready ground pork produce off-site, and the remaining packages were ground/produced on-site at the retail store. Packages were obtained from grocery stores, supercenters, and other markets that sold fresh meats. Sampling location was recorded, as well as purchase date, and retail case temperature. Samples were coded and shipped to Texas Tech

University under refrigerated conditions. Prior to shipping, each package was placed in a sealed plastic bag to prevent cross-contamination between packages in the shipping container. All information on the package and label were subsequently recorded. This information included, but was not limited to: sell by date, brand, label claims, establishment number, package type, and ingredients. After package data was recorded, all identifiers were removed and packages were assigned with a three-digit code prior to analysis.

Five, 2.5cm cores of ground pork were aseptically removed from each package and placed in a Whirl Pack[®] bag. The cores were mixed thoroughly, and 25-g aliquots were removed for both FDA and USDA analyses (Figure 2). Additionally, a 10-g aliquot from 6 different packages representing a single location and package type was homogenized to create a composite. A 25-g aliquot was then taken from the homogenate to create a composite. Composite samples were diluted 10-fold in buffered peptone water (BPW), stomached, and enriched for approximately 24 h at 37°C. Samples were then subjected to real-time PCR (RT-PCR; BAX, Dupont, Wilmington, DE; AOAC 100201). If a pooled composite sample was positive for *Salmonella*, individual packages represented in the composite were tested using the same procedure (Figure 3).

USDA Isolation

Individual ground pork samples (25 g) from a positive composite sample were diluted 10 fold with 225 mL BPW and were stomached at 230 rpm for 2 minutes (Seward Stomacher 400, Davie, FL). Samples were placed in a 37°C incubator for approximately 24 h prior to analysis. Post-enrichment, samples were subjected to RT-PCR analysis to determine if *Salmonella* was present in the sample. If the sample was positive, samples were subjected to USDA *Salmonella* isolation techniques as described by USDA FSIS Microbiological Laboratory Guidelines (FSIS,

2012). The enrichment was placed in tetrathionate (TT) and Rappaport-Vassiladis (RV) media and incubated at 37°C and 42°C, respectively for 18-24 h. After incubation, samples were streaked onto brilliant green sulfa (BGS) and xylose lysine tergit-4 (XLT4) agar. Phenotypical colonies were streak plated on new selective media prior to biochemical confirmation as described below.

FDA Isolation

After a sample was deemed positive following RT-PCR analysis, a 25-g aliquot of ground pork was placed into 225 mL in a sterile container of lactose broth for enrichment. Samples were stomached at 230 rpm for 2 min and incubated at 25°C for 1 h. Samples were then enriched at 35°C for approximately 24 h. Procedures were followed for *Salmonella* isolation as described in the FDA Bacteriological Analytical Manual (FDA BAM; 2009). After incubation, 0.1 mL was transferred to 10 mL RV medium, and an additional 1 mL of enrichment was transferred to TT broth. After vortexing, the RV media was incubated approximately 24 h at 42°C, and the TT media was incubated for approximately 24 h at 35 ± 2°C. After incubation, one loopful (10 µL) from RV media was streaked onto bismuth sulfite (BS) agar, xylose lysine desoxycholate (XLD) agar, and Hektoen enteric (HE) agar. The same process was repeated for TT media on all agar types. The plates were incubated for approximately 24 h at 35°C, and were subsequently examined for the presence of phenotypical colonies on each agar.

Confirmation

Colonies exhibiting phenotypical *Salmonella* characteristics from any agar in both USDA and FDA analysis were restreaked once again onto the same selective media from which they were pulled and were subjected to further biochemical confirmation. Isolates were subjected to latex agglutination (Oxoid, Thermo Scientific, UK) to aid in the confirmation of *Salmonella*.

Additionally, isolates were streaked onto triple sugar iron slants and MacConkey agar as further steps to aid in the confirmation of *Salmonella* via metabolic characteristics. After these steps, multiple isolates from each selective media were incubated and frozen in 10% glycerol for storage at -80°C. Isolates were also placed on tryptic soy agar (TSA) slants for shipment to Ohio State University for further antimicrobial resistance and serotyping analysis. Finally, to confirm the effectiveness of RT-PCR (BAX) in the detection of *Salmonella* in the packages, 144 packages determined to be negative after RT-PCR were subjected to USDA and FDA *Salmonella* isolation techniques. None of the packages were found to contain *Salmonella* after these analyses.

Antimicrobial Resistance Profiling

Antimicrobial resistance was evaluated by determining the minimum inhibitory concentration (MIC) to a standard panel of 15 antibiotics (Amoxicillin/Clavulanic Acid, Ampicillin, Azithromycin, Ceftoxitin, Ceftiofur, Ceftriaxone, Chloramphenicol, Ciproflaxin, Gentamicin, Naladixic Acid, Streptomycin, Sulfisoxazole, Tetracycline, and Trimethoprim/Sulfamethoxazole) using micro-broth dilution. Isolates were first inoculated in sterile water and were analyzed on a spectrophotometer and adjusted to a 0.5 McFarland standard. An aliquot of 10 µL was then inoculated into 10 mL Mueller-Hinton broth. Then, 96-well plates containing predetermined concentrations of antibiotics (NARMS CMV3AGNF MIC panel, TREK Diagnostic Systems, Cleveland, OH) were inoculated and incubated for 18 to 24 h at 35°C. Growth was visually monitored (Trek Diagnostics Systems Inc., Cleveland, OH) to determine susceptibility or resistance.

Isolate Characterization and Serotyping

To examine the genetic similarity of individual *Salmonella* isolates, pulse-field gel electrophoresis (PFGE) genotyping (CHEF-DRIII; Bio-Rad Laboratories, Hercules, CA) was performed on total genomic DNA. Agarose plugs prepared with the *Salmonella* isolates were digested using XbaI (Promega, Madison, WI) following previously reported protocols (Ribot et al., 2006). After electrophoresis, banding patterns were compared and levels of similarity assigned using generally accepted criteria (Tenover et al, 1995). *Salmonella* isolates were compiled into pulsotypic groups by using the Dice coefficient similarity index and the unweighted pair-group method with arithmetic averages (UPGMA) with clustering settings of 1.00% optimization and 1.00% band position tolerance via Bionumerics software (Applied Maths, Kortrijk, Belgium). A summary of isolate characterization can be seen in Appendix A. After the genetic similarity was ascertained, *Salmonella* isolates were shipped to the National Veterinary Services Laboratory in Ames, IA for serotyping.

Statistical Analysis

Crude prevalence estimates were calculated as the simple proportion of all packages from which *Salmonella* isolate was recovered. Crude prevalence was summarized for all packages and by region, season, package type, and grind location. The ability of the FDA and USDA culture methodologies to recover *Salmonella* from the same packages of ground pork was compared using McNemar's chi square test to detect disagreement and the kappa statistic to estimate agreement beyond that expected by chance.

Adjusted prevalence estimates were obtained using logistic regression mixed models to estimate the adjusted probability that an individual package of ground pork would be contaminated with *Salmonella*. The store in which the package was purchased was included in

each model as a residual random effect. Variables representing the season, geographical region, package type, and grind location were tested for inclusion in the model as categorical fixed effects using a forward stepwise model building procedure. All data were analyzed using commercially available software (The SAS System v. 9.3, The SAS Institute, Cary, SC) with the Tukey option to separate mean differences. Mean differences were separated at $P \leq 0.05$ for all comparisons.

Results and Discussion

Prevalence

A total of 865 packages of ground pork were collected across the U.S. from 50 different cities (Table 1). Approximately 55% of the packages collected were overwrap packages, 6% were chub packages, 20% were modified atmosphere packages (MAP), and 19% were wrapped in butcher paper with or without a plastic liner (Other). A total of 12 packages (1.39%) were determined to harbor *Salmonella* (Table 2). Of the packages determined to harbor *Salmonella*, 75% (9 of 12) were case-ready packages packaged off-site from the retail location. Also, 83.3% of the positive packages (10 of 12) were collected in the Fall season (September – November). Eight of the positive packages were collected in September, and two of the positive packages were collected in November. The remaining packages testing positive ($n = 2$) were collected in February. Overwrap packaging comprised 50% of *Salmonella* positive retail ground pork packages (6 of 12), while modified atmosphere packaging (MAP) and chub packaging were 33.3 and 16.7%, respectively. The majority of the positive packages were collected from the East sampling region (83.3%; 10 of 12), with the other 2 packages collected in the Central/Midwest sampling region. The overall prevalence of *Salmonella* in retail pork was very low, indicating

that *Salmonella* in retail ground pork may not be a large contributor to human foodborne illness in the United States.

While little research has been conducted in the U.S. on ground pork prevalence, similar prevalence results have been observed in other countries. Irish pork prevalence was determined to be 2.9% (Boughton et al., 2004). Additionally, another study in Ireland reported a *Salmonella* prevalence of 2% (Prendergast et al., 2009). *Salmonella* surveillance of pork products in Belgium reported prevalence between 0.3 and 4.3% (Delhalle et al., 2009). Two studies conducted in one metropolitan region in the U.S. reported that 2% and 3.3% of retail pork products were contaminated with *Salmonella* (Zhao et al., 2006). In another study conducted in the U.S. Duffy et al. (2000) reported *Salmonella* contamination in 8.3 and 10.4% of whole muscle cuts and enhanced whole muscle pork cuts, respectively. Greater *Salmonella* contamination was reported in Vietnam where Van et al. (2007) reported 62% of retail pork products contained *Salmonella*. *Salmonella* surveillance in other meat products has also been investigated in the U.S. Mollenkopf et al. (2010) reported 6.3% of pork chops and 5% of pork ribs were contaminated with *Salmonella* in two U.S. regions. In the Washington, D.C. area, over 50% of turkey samples were positive for *Salmonella* (Zhao et al., 2001). A nationwide study in the U.S. determined ground beef *Salmonella* contamination to be 0.66% (Vipham et al., 2012); however, samples were only obtained during Spring. Another study by White et al. (2001) reported 6% of ground beef samples were positive for *Salmonella* in one U.S. metropolitan area, and 35 and 24% of ground chicken and turkey, respectively contained *Salmonella*.

Multiple package level factors such as region, season, package type, and grind location were analyzed to determine if they played a role in the *Salmonella* prevalence of retail ground

pork. There was a tendency for *Salmonella* contamination to be different among regions ($P = 0.07$; Figure 4; Table 2). There was a difference between *Salmonella* prevalence across seasons ($P = 0.05$; Figure 5; Table 2). More *Salmonella* was isolated from packages in the fall season than the Winter/Spring season ($P = 0.04$). The Fall season yielded the greatest *Salmonella* recovery at 3.47% compared to 0.76% for the Winter/Spring season. Interestingly, no *Salmonella* was isolated in the Summer season. Greater *Salmonella* prevalence in the Fall season and the East region may be the result of two stores in the same town that yielded 50% (6 of 12) of the positive isolates in this study indicating that store may play a larger role than season or region when estimating ground pork *Salmonella* prevalence at retail. Naumova et al (2007) reported increased foodborne illness via *Salmonella* during the summer months. Also, Barkocy-Hallagher et al. (2003) reported less *Salmonella* on the hides and feces of cattle during the winter and spring seasons. Biendo et al. (2003) reported that human clinical infections of *Salmonella* Enteridis may be season dependent. In this study, seasonality did not greatly affect prevalence in ground pork. This may be partially explained by the thermoneutral environment in which pigs are produced. A study by Schmidt et al. (2012) sampled pork processing facilities, and while there were differences between seasons, no strong relationship was ascertained between *Salmonella* contamination and season. Sorensen et al. (2007) reported seasonal variance on *Salmonella* prevalence at pork abattoirs in Denmark.

No differences were observed between the different package types that were collected ($P = 0.29$). A greater number of chub type packages (3.85%) were contaminated with *Salmonella* in comparison to other package types (Table 2; Figure 6). A total of 1.26% of overwrap packages collected were determined to contain *Salmonella*, whereas chub and MAP packages contained 3.85 and 2.29%, respectively (Table 2; Figure 6). The majority of the packages collected for

analysis were overwrap (55%), and a possible indication as to why the overwrap package *Salmonella* prevalence is so low. Additionally, the majority of retail pork available for sale in the stores we sampled was packaged in overwrapped trays. The number of overwrap packages may additionally be increased because that packaging technology is primarily used by stores who grind their own pork with butcher paper wrapping being the second most common package type. No *Salmonella* was isolated from butcher-wrapped (other) packages throughout the study (Table 2; Figure 6). A study by Vipham et al. (2012) determined that there was no relationship between package type and *Salmonella* recovery in ground and whole muscle beef cuts collected in the United States. Due to the lack of available retail surveillance studies in which package type was accounted for, no other data was discovered in the literature to establish or refute a link between *Salmonella* contamination and retail pork package type.

There was no difference in the *Salmonella* prevalence of retail store-ground pork compared to case-ready packages ($P = 0.17$; Figure 7; Table 2). A total of 9 case-ready packages were contaminated with *Salmonella* (1.90%), whereas only 3 store-ground packages contained *Salmonella* (0.77%; Table 2). Case-ready ground pork is subject to USDA microbiological testing, whereas store-ground pork is subject to FDA pathogen tests. For purposes of this study, both FDA and USDA *Salmonella* isolation protocols were conducted simultaneously on a single package to compare the effectiveness of each testing methodology. The USDA-FSIS method was the most effective method to isolate *Salmonella* compared to FDA isolation ($P = 0.01$). All but one isolate was recovered utilizing the USDA *Salmonella* isolation protocol; whereas, the FDA *Salmonella* isolation protocol was able to recover only 3 isolates from retail pork packages. These data suggests that the two *Salmonella* isolation methodologies produce somewhat inconsistent results. A Kappa statistic of 0.26 (95% C.I.: -0.04 – 0.57) was calculated by

comparing the agreement of the methodologies, thus suggesting that there is only a 26% agreement between methods beyond chance in terms of recovering *Salmonella* from retail ground pork samples. While no information was discovered in the literature directly comparing the USDA-FSIS and FDA methods for *Salmonella* isolation, Warburton et al. (1991) reported that the USDA isolation method was more effective in isolating *Listeria monocytogenes* in food products.

A total of six different serotypes were recovered from the 12 packages and 61 isolates obtained (Table 3). The serotypes isolated included: Infantis, 4,5,12:i:-, Brandenburg, Typhimurium var 5-, Seftenberg, and Johannesburg. Only two packages contained multiple serotypes. All other isolates from packages containing *Salmonella* were found to be the same serotype. *Salmonella* Typhimurium was the most commonly isolated serotype (5 of 12 packages) followed by Johannesburg (3 of 12 packages). One of the packages containing multiple serotypes contained Typhimurium and Seftenberg, and the other package with multiple serotypes contained *Salmonella* Seftenberg and Johannesburg. Korsak et al. (2003) reported the presence of *Salmonella* Seftenberg, Typhimurium, Infantis, and Brandenburg in the feed of swine, the large intestine, as well as the surface of the carcass after harvest. In the Netherlands Swanburg et al. (2001) also discovered Typhimurium, Brandenburg, and Infantis from pork carcasses. A study by Schlosser et al. (2000) reported the presence of *Salmonella* Johannesburg, Typhimurium and Infantis on pork carcasses. Additionally, the researchers isolated Typhimurium and Infantis along with other species in raw ground pork (Schlosser et al., 2000). *Salmonella* serotype 4,5,12:i:- was linked to a nationwide outbreak in France traced back to dried pork sausage (Bone et al., 2010).

Antimicrobial Resistance

Antimicrobial resistance was determined via minimum inhibitory concentration analysis utilizing a NARMS pork antibiotic panel (Table 4). A total of 60 isolates were analyzed to determine antimicrobial resistance profiles. More resistance to sulfisoxazole was observed than to any other antimicrobial. A total of 40 isolates exhibited resistance to sulfisoxazole. Thirty-six isolates were classified as resistant to ampicillin. Thirty seven isolates were classified as resistant to tetracycline. Only 1 of 60 isolates exhibited resistance to trimethoprim/sulfamethoxazole. None of the isolates were determined to be resistant to ciprofloxacin, ceftiofur, ceftriaxone, or naladixic acid. Overall, the number of isolates exhibiting resistance to antibiotics commonly used to treat *Salmonella* infections in humans is minimal and is most likely not a significant public health concern. Perhaps of more importance than frequency of resistance may be the lack of resistant isolates to certain antimicrobials. The CDC reports that severe *Salmonella* infections in humans may be treated with fluoroquinolones, third-generation cephalosporins, and ampicillin (for susceptible infections). None of the *Salmonella* isolates from this study were resistant to extended spectrum cephalosporins. Additionally, none of the isolates were resistant to flouroquinolones.

Antibiotic resistant *Salmonella* may be cause for public health concern due to the fact that conventional treatments may not be effective in mitigating human or animal illness, and many of the resistance mechanisms are transferrable to other bacteria (Van et al., 2007). Resistance may be a product of selection pressure caused via the use of antimicrobials and antibiotics because resistant bacteria are able to survive in an environment when the antimicrobial is present (White et al., 2001). The issue of resistance attributed to use in livestock has been addressed previously. For example, the use of fluoroquinolones in food producing animals was prohibited by the FDA

in the U.S in 1997 (Federal Register, 1997). The use of fluoroquinolones was abolished because fluoroquinolones are utilized to treat severe human infections (Conte, 1995; Wilcox and Spencer, 1992) and resistance to this antibiotic is a public health concern (Beam, 1994; Angulo et al., 2000). Most *Salmonella* infections in food producing livestock do not require treatment with antibiotics and can be managed by the immune system typically within 5 to 7 d, however, 3 to 10% of cases result in bacteremia and require antibiotic treatment (White et al., 2001). In systemic *Salmonella* infections, the use of antibiotics such as ciproflaxin and ceftriazone may prevent fatality (Hohmann, 2001; Glynn et al., 1998).

Conclusion

Salmonella is a foodborne pathogen of interest for the food industry with the ability to cause illness and death. The overall observed prevalence of *Salmonella* in ground pork from this study was very low; indicating the presence of this pathogen in ground pork is not a major public health concern in the U.S. This may be, in part, due to control measures implemented via the HACCP system as well as harvest and processing procedures applied to pork products prior to consumption. Current testing procedures have become more efficient in identifying contaminated products; however, there are discrepancies between the USDA and FDA *Salmonella* isolation methods. The ability of the USDA and FDA testing methodologies should be further investigated to optimize their effectiveness. Our results indicate multiple *Salmonella* serotypes may contaminate ground pork, and these serotypes are similar to those previously isolated in other studies involving pigs and pork. Additionally, based on these data, *Salmonella* isolated from ground pork at retail does not contain bacteria resistant to important antibiotics such as extended spectrum cephalosporins and fluoroquinolones that may be used to treat severe

Salmonella infections. The industry should continue to utilize technologies and practices to reduce pathogens in pork products.

References

- Angulo, F.J., K.R. Johnson, R.V. Tauxe, and M.L. Cohen. 2000. Origins and consequences of antimicrobial-resistant nontyphoidal *Salmonella*: implications for the use of fluoroquinolones in food animals. *Microbial Drug Resistance*. 6: 77-83.
- Anonymous. 2001. Report of the European Parliament and to the Council on the measures to be put in force for the control and prevention of zoonoses. Commission of the European Communities, Brussels, 2001/0176. Available at : at: <http://europa.eu.int/eur-lex/en/com/pdf/2001/enp501PC0452p01.pdf>.
- Barkocy-Gallagher, G.A., T.M. Arthur, M. Rivera-Betancourt, X. Nou, S.D. Shackelford, T.L. Wheeler, and M. Koohmaraie. 2003. Seasonal prevalence of Shiga toxin-producing *Escherchia coli*, including O157:h7 and non-O157 serotypes, and *Salmonella* in commercial beef processing plants. *Journal of Food Protection*. 66: 1978-1986.
- Beam, Jr. T.R. 1994. Fluoroquinolones in animal feeds. *ASM News* 60: 348-349.
- Biendo, M., G. Laurans, D. Thomas, O. Dechepy, F. Hamdad-Daudi, B. Canarelli, and F. Eb. 2003. Regional dissemination of *Salmoella* enteric serovar Enteridis is season dependent. *Clinical Microbiology and Infection*. 2003. 9: 360-369.
- Bone A, Noel H, Le Hello S, Pihier N, Danan C, Raguenaud ME, Salah S, Bellali H, Vaillant V, Weill FX, Jourdan-da Silva N. Nationwide outbreak of *Salmonella* enterica serotype 4,12:i:- infections in France, linked to dried pork sausage, March-May 2010. *Euro Surveill*. 2010;15(24):pii=19592. Available online: <http://www.eurosurveillance.org/ViewArticle.aspx?ArticleId=19592>
- Botteldoorn, N., M. Heyndrickx, N. Rijpens, K. Grijspeerdt, and L. Herman. 2003. *Salmonella* on pig carcasses: positive pigs and cross contamination in the slaughterhouse. *Journal of Applied Microbiology*. 95: 891-903.
- Bottemiller, H. 2012. Consumer reports finds most pork contaminated with Yersinia. *Food Safety News*. November 27, 2012. Available: <http://www.foodsafetynews.com/2012/11/consumer-reports-finds-most-pork-positive-for-yersinia/#.U7rfhpRdU74>
- Boughton, C., F.C. Leonard, J. Egan, G. Kelly, P. O'Mahoney, B.K. Markey, and M. Griffin. 2004. Prevalence and number of *Salmonella* in Irish retail pork sausages. *Journal of Food Protection*. 67: 1834-1839.
- CDC. 2014. Center for Disease Control and Prevention. CDC 2011 Estimates of foodborne illness in the United States. Available: <http://www.cdc.gov/foodborneburden/2011-foodborne-estimates.html>
- Conte, J.E. 1995. Manual of antibiotics and infectious diseases. Williams & Wilkins, Baltimore, MD.

- Daube, G., J.M. Dumont, M.L. Libotte-Chasseur, Y. Ghafir, and L. De Zutter. 1998. Serovars of *Salmonella* strains isolated from foods of animal origin in Belgium. In Proceeding of the Third Conference in Food Microbiology. Liege, Belgium, 10 September, pp. 70-71.
- Delhalle, L., C. Saegerman, F. Farnir, N. Korsak, D. Maes, W. Messens, L. De Sadeleer, L. De Zutter, and G. Daube. 2009. *Salmonella* surveillance and control at post-harvest in the Belgian pork meat chain. *Food Microbiology*. 26: 265-271.
- Duffy, E.A., K.E. Belk, J.N. Sofos, G.R. Bellinger, A. Pape, and G.C. Smith. 2000. Extent of microbial contamination in United States pork retail products. *Journal of Food Protection*. 64: 172-178.
- Duffy, E.A., K.E. Belk, J.N. Sofos, G.R. Bellinger, A. Pape, and G.C. Smith. 2000. Extent of microbial contamination in United States pork retail products. *Journal of Food Protection*. 64: 172-178.
- Escartin, E.F., J.S. Lozano, O.R. Garcia. 2000. Quantitative survival of native *Salmonella* serovars during storage of frozen raw pork. *International Journal of Food Microbiology*. 54: 19-25.
- FDA. 2013. #213 – Guidance for industry: New animal drugs and new animal drug combination products administered in or on medicated food or drinkin water of food-producing animals: recommendations for drug sponsors for voluntarily aligning product use conditions with FGI #209. Available: <http://www.fda.gov/downloads/animalveterinary/guidancecomplianceenforcement/guidanceforindustry/ucm299624.pdf>
- Federal Register. May 22, 1997. 62(99): 27944-27947.
- Glynn, M.K., C. Bopp, W. Dewitt, P. Dabney, M. Mokhtar, and F.J. Angulo. 1998. Emergence of multidrug-resistant *Salmonella enteric* serotype typhimurium DT104 infections in the United States. *New England Journal of Medicine*. 338: 1333-1338.
- Hald, T.E., D. Vose, H.D. Wegener, and T. Koupeev. 2004. A Bayesian approach to quantify the contribution of animal-food sources to human salmonellosis. *Risk Analysis*. 24: 255-269.
- Hohmann, E.L. 2001. Nontyphoidal salmonellosis. *Clin Infect Dis*. 32: 263-269.
- ICMSF. 1996. *Microorganisms in Foods. Characteristics of microbial pathogens*. Blackie Academic & Professional, London.
- Korsak, N., V. Jacob, B. Groven, G. Etienne, B. China, Y. Ghafir, and G. Daube. 2003. *Salmonella* contamination of pigs and pork in an integrated pig production system. *Journal of Food Protection*. 66: 1126-1133.
- Lo Fo Wong, D.M.A., T. Hald, P.J. van der Wolf, and M. Swanburg. 2002. Epidemiology and control measures for *Salmonella* in pigs and pork. *Livestock Production Science*. 76: 215-222.

- Mead, P.S., L. Slutsker, V. Dietz, L.F. McCaig, J.S. Bresee, C. Shapiro, P.M. Griffin, and R.V. Tauxe. 1999. Food-related illness and death in the United States. *Synposes*. 5: 607-625. Available: www.cdc.gov/ncidod/EID/vol5no5/meat.htm.
- Miller, G.Y., X. Liu, P.E. McNamara, and D.A. Barber. 2005. Influence of *Salmonella* in pigs preharvest and during pork processing on human health costs and risks from pork. *Journal of Food Protection*. 68: 1788-1798.
- Mollenkopf, D.F., K.E. Kleinhenz, J.A. Funk, W.A. Gebreyes, and T.E. Wittum. 2011. *Salmonella enterica* and *Escherichia coli* harboring *bla*_{CMY} in retail beef and pork products. 8: 333-336.
- Naumova, E.N., J.S. Jagai, B. Matays, A. DeMaria, I.B. MacNeill, and J.K. Griffiths. 2007. Seasonality in six enterically transmitted diseases and ambient temperature. *Epidemiology Infections*. 135: 281-292.
- Oosterom, J., R. Dekker, G.J.A. de Wilde, F. van Kempen de Troye, and G.B. Engels. 1985. Prevalence of *Campylobacter jejuni* and *Salmonella* during pig slaughtering. *Veterinary Quarterly*. 7: 31-34.
- Pires, S.M. and T. Hald. 2010. Assessing the differences in public health impact of *Salmonella* subtypes using a Bayesian microbial subtyping approach for source attribution. 7: 143-151.
- Prendergast, D.M., S.J. Duggan, U. Gonzales-Barron, S. Fanning, F. Butler, M. Cormican, and G. Duffy. 2009. Prevalence, numbers and Characteristics of *Salmonella* spp. on Irish retail pork. *International Journal of Food Microbiology*. 131: 233-239.
- Scallan, E., R.M. Hoekstra, F.J. Angulo, R.V. Tauxe, M.A. Widdowson, S.L. Roy, J.L. Jones, and P.M. Griffin. 2011. Foodborne illness acquired in the United States- Major Pathogens. *Emerging Infections Diseases*. 17:7-15.
- Schlosser, W., A. Hogue, E. Ebel, B. Rose, R. Umholtz, K. Ferris, and W. James. 2000. Analysis of *Salmonella* serotype from selected carcasses and raw ground products sampled prior to implementation of the pathogen reduction; hazard analysis and critical control point final rule in the U.S. *International Journal of Food Microbiology*. 58: 107-111.
- Schmidt, J.W., D.M. Brichta-Harhay, N. Kalchayanand, J.M. Bosilevac, S.D. Shackelford, T.L. Wheeler, and M. Koohmaraie. 2012. Prevalence, enumeration, serotypes, and antimicrobial resistance phenotypes of *Salmonella* enteric on carcasses at two large United States pork processing plants. *Applied and Environmental Microbiology*. Available online: <http://aem.asm.org/content/early/2012/02/07/AEM.07015-11.full.pdf>.
- Sorensen, L.L., H. Wachmann, and L. Alban. 2007. Estimation of *Salmonella* prevalence on individual-level based upon pooled swab samples from swine carcasses. *Veterinary Microbiology*. 119: 213-220.

- Swanburg, M., P.J. van der Wolf, H.A.P. Urlings, J.M.A. Snijders, and F. van Knapen. 2001. *Salmonella* in slaughter pigs: the effect of logistic slaughter procedures of pigs on the prevalence of *Salmonella* in pork. *International Journal of Food Microbiology*. 70: 231-242.
- Van, T.T.H., G. Moutafis, T. Istivan, L.T. Tran, and P.J. Coloe. 2007. Detection of *Salmonella* spp. in retail raw food samples from Vietnam and characterization of their antibiotic resistance. 2007. *Applied and Environmental Microbiology*. 73: 6885-6890.
- Van, T.T.H., G. Moutafis, T. Istivan, L.T. Tran, and P.J. Coloe. 2007. Detection of *Salmonella* spp. in retail raw food samples from Vietnam and characterization of their antibiotic resistance. 2007. *Applied and Environmental Microbiology*. 73: 6885-6890.
- Vipham, J.L., M.M. Brashears, G.H. Loneragan, A.Echeverry, J.C. Brooks, W.E. Chaney, and M.F. Miller. 2012. *Salmonella* and *Campylobacter* baseline in retail ground beef and whole-muscle cuts purchased during 2010 in the United States. *Journal of Food Protection*. 75: 2110-2115.
- Warburton, D.W., J.M. Farber, A. Armstrong, R. Caldeira, T. Hunt, S. Messier, R. Plante, N.P. Tiwari, and J. Vinet. 1991. A comparative study of the FDA and USDA methods for the detection of *Listeria monocytogenes* in foods. *International Journal of Food Microbiology*. 13: 105-118.
- White, D.G., S. Zhao, R. Sudler, S.Ayers, S. Friedman, S. Chen, P.F. McDermott, S. McDermott, D.D. Wagner, and J. Meng. 2001. The isolation of antibiotic-resistant *Salmonella* from retail ground meats. *The New England Journal of Medicine*. 345: 1147-1154.
- White, D.G., S. Zhao, R. Sudler, S.Ayers, S. Friedman, S. Chen, P.F. McDermott, S. McDermott, D.D. Wagner, and J. Meng. 2001. The isolation of antibiotic-resistant *Salmonella* from retail ground meats. *The New England Journal of Medicine*. 345: 1147-1154.
- White, D.G., S. Zhao, R. Sudler, S.Ayers, S. Friedman, S. Chen, P.F. McDermott, S. McDermott, D.D. Wagner, and J. Meng. 2001. The isolation of antibiotic-resistant *Salmonella* from retail ground meats. *The New England Journal of Medicine*. 345: 1147-1154.
- Wilcox, M.H. and R.C. Spencer. 1992. Quinolones and *Salmonella* gastroenteritis. *J. Antimicrobial Chemotherapy*. 30: 221-228.
- Zhao, C., G.E. B. Ge, J. de Villena, R. Sudler, E. Yeh, S. Zhao, D.G. White, D. Wagner, and J. Meng. 2001. Prevalence of *Campylobacter* spp., *Escherichia coli*, and *Salmonella* Serovars in Retail Chicken, Turkey, Pork, and Beef from the greater Washington, D.C. area. *Applied and Environmental Microbiology*. 67: 5431-5436.
- Zhao, S., P.F. McDermott, S. Friedman, J. Abbott, S. Ayers, A. Glenn, E. Hall-Robinson, S.K. Hubert, H. Harbottle, R.D. Walker, T.M. Chiller, and D.G. White. 2006. Antimicrobial

resistance and geneted relatedness among *Salmonella* from retail foods of animal origin:
NARMS retail meat surveillance. Foodborne Pathogens and Disease. 3: 106-117.

Final Report - Figures and Tables



Figure 1. Sampling locations for Retail Ground Pork to determine the prevalence of *Salmonella*

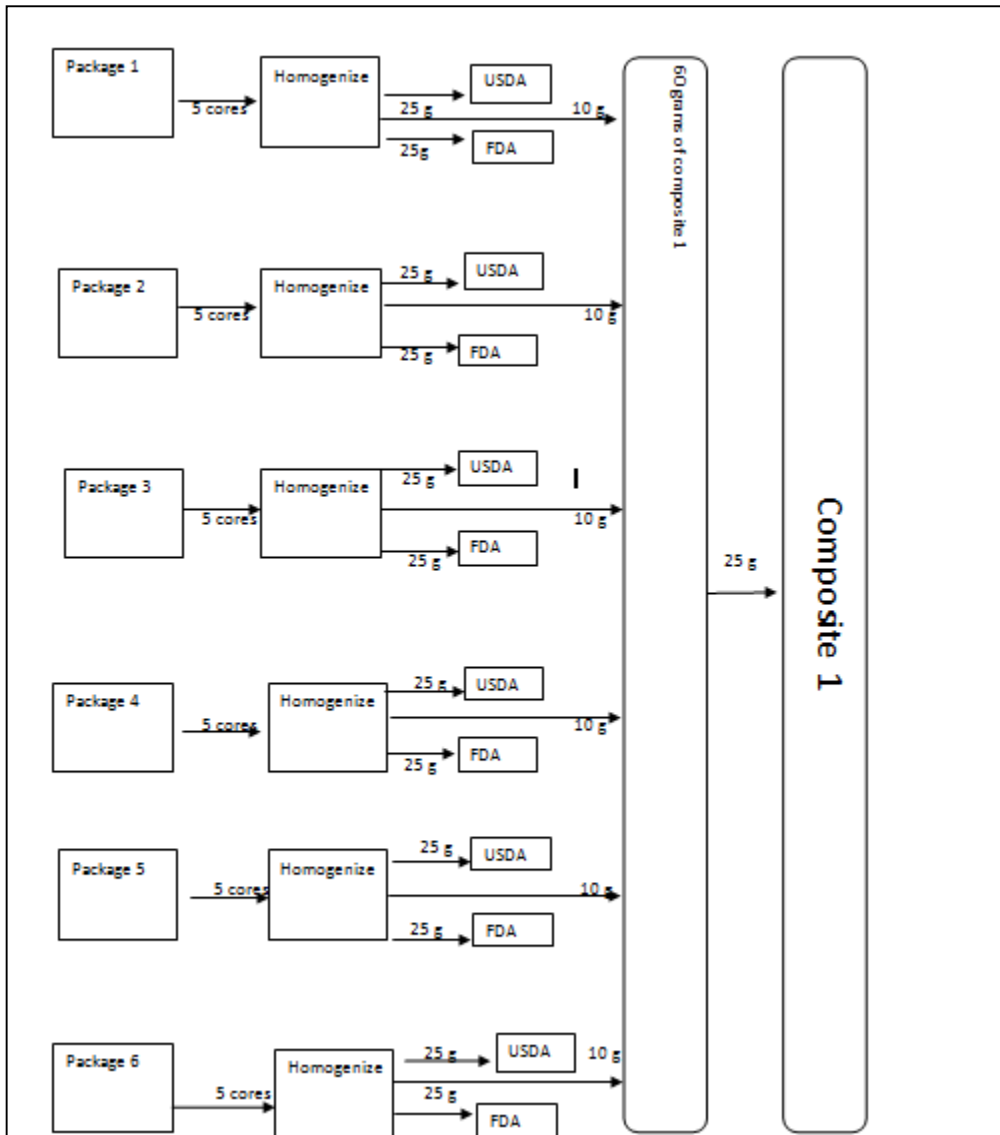

Figure 2. Sampling protocol for retail ground pork composites to determine the presence of *Salmonella*

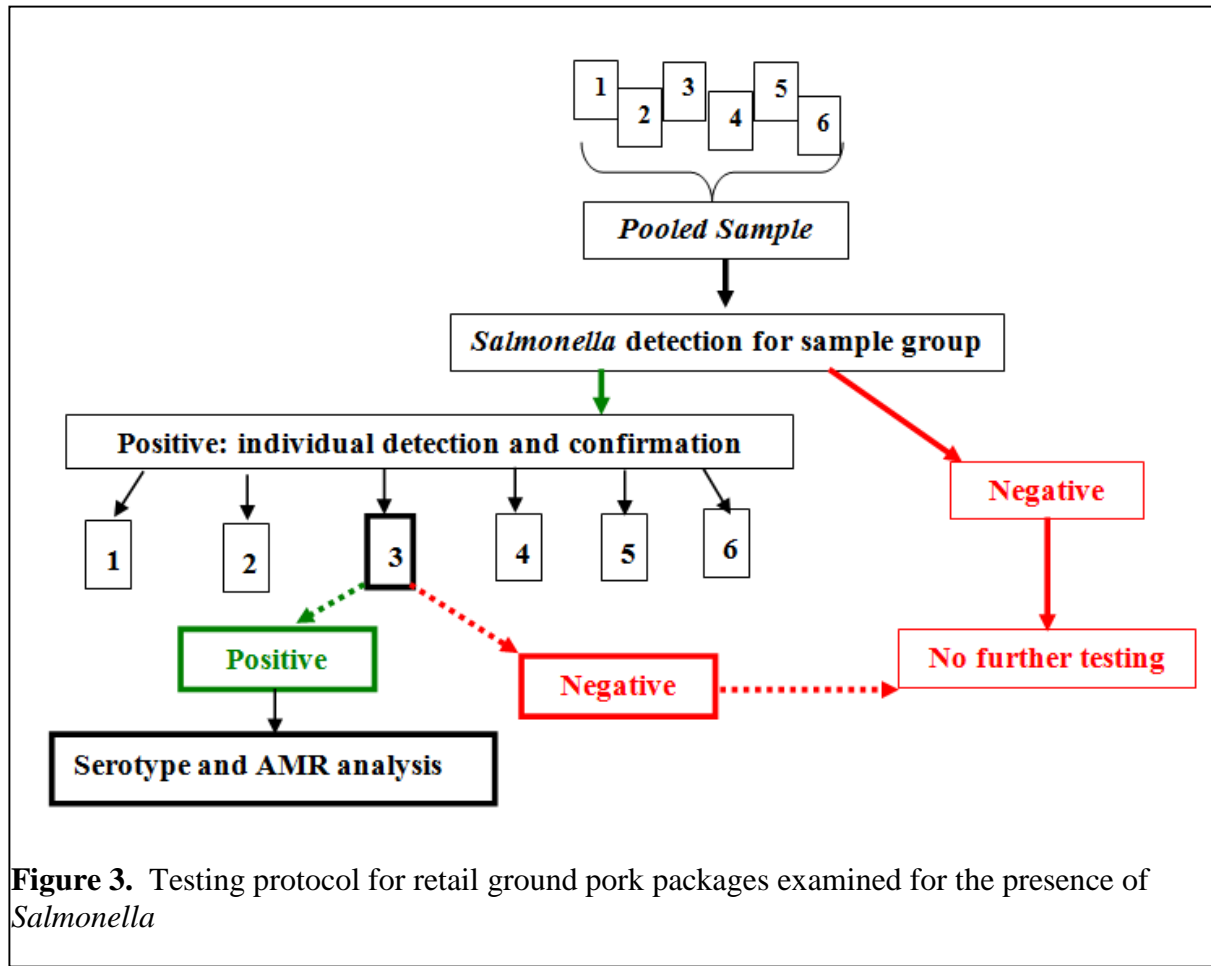

Figure 3. Testing protocol for retail ground pork packages examined for the presence of *Salmonella*

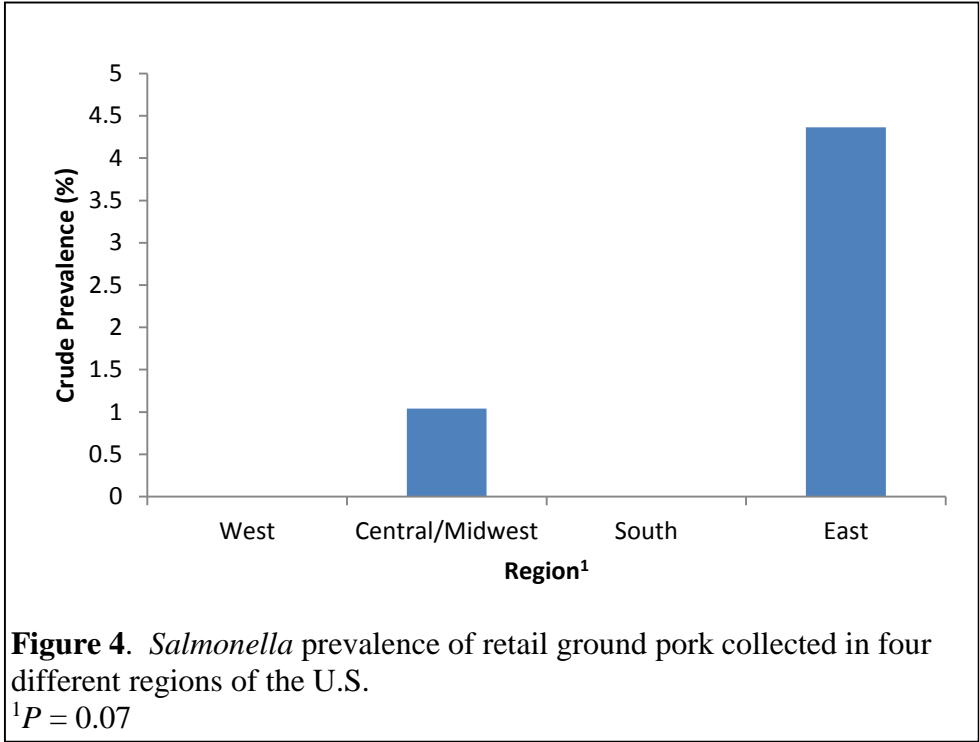

Figure 4. *Salmonella* prevalence of retail ground pork collected in four different regions of the U.S.

¹*P* = 0.07

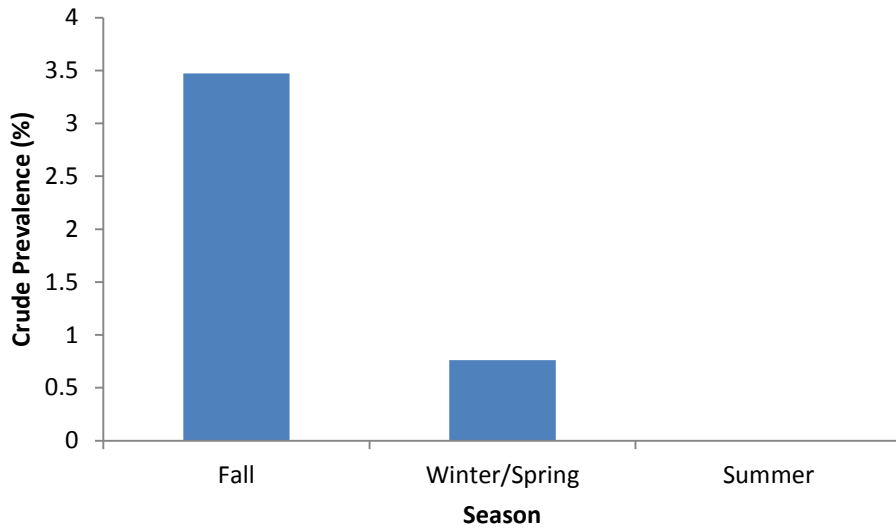

Figure 5. *Salmonella* prevalence of U.S. retail ground pork during different seasons
Fall: September – November; Winter/Spring : January – March; Summer: June - August
¹*P* = 0.05

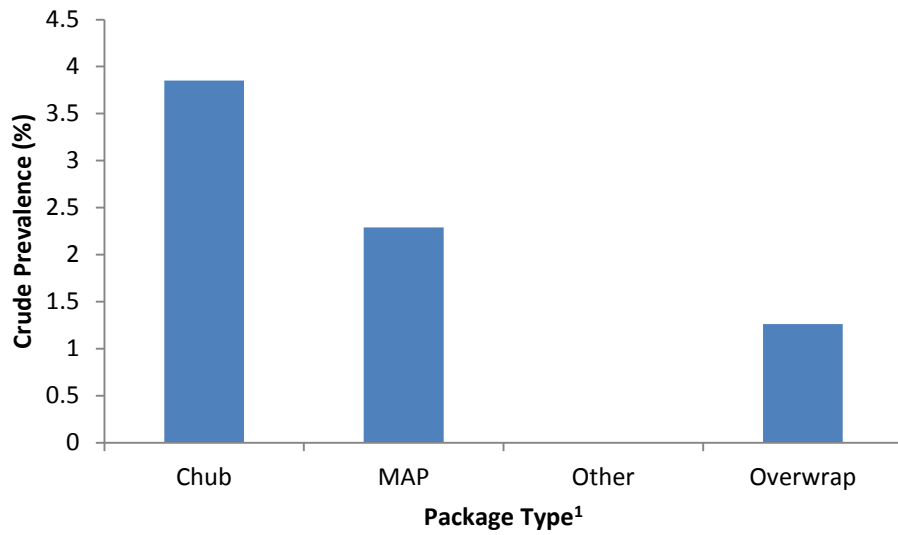

Figure 6. *Salmonella* prevalence of different package types containing ground pork from U.S. retailers

MAP = Modified atmosphere packaging

Other – butcher paper with or without a plastic liner

¹*P* = 0.29

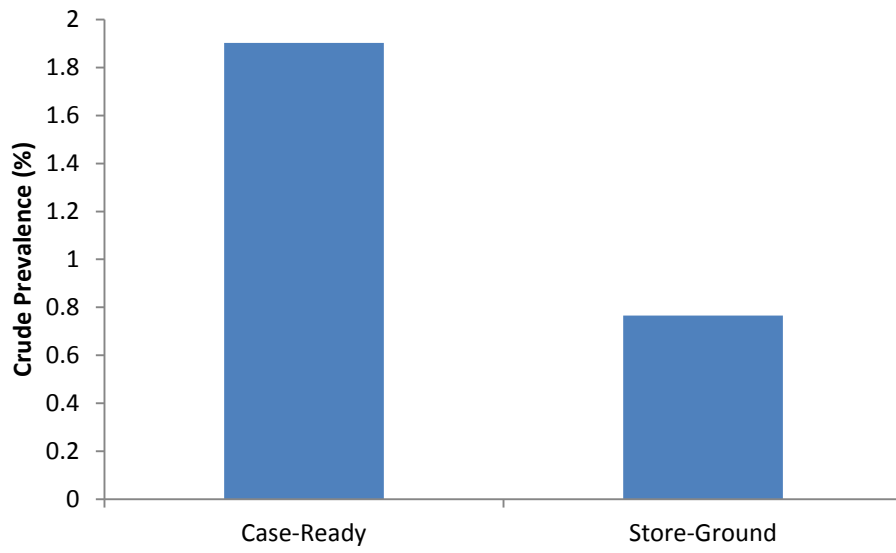

Figure 7. *Salmonella* prevalence of case-ready and store-ground retail ground pork collected in the U.S.
 $P = 0.17$

Table 1. Location and package type of ground pork collected across the United States to monitor the presence of *Salmonella*

City	State	Package Type				Grinding Location	
		Overwrap	Chub	MAP*	Other*	Case-Ready	Store Ground
Loveland	CO	3				3	
Fort Collins	CO	12	6		3	18	3
Willits	CA	13		11		12	12
Fort Smith	AR	28			11	18	21
Van Buren	AR				3		3
Jacksonville	AR	6				6	
Shafter	CA				12		12
Bakersfield	CA	3	3	6		12	
Lubbock	TX	46		20	6	36	36
Lincoln	NE	26	31	12	3	36	36
Cuba City	WI				18		18
Platteville	WI	6				6	
Gainsville	FL	20		4		9	15
Hiliard	OH	4		3		4	3
Columbus	OH	25		7		23	9
Upper Arlington	OH	4				1	3
Chandler	AZ	8		4		12	
Queen Creek	AZ				12		12
State College	PA	30		18		28	20
Raleigh	NC			11	12	11	12
North Bend	WA	12				12	
Yakima	WA	4				4	
Puyallup	WA	8					8
Salt Lake City	UT	12				12	
West Valley City	UT				12		12
Hunt Valley	MD	10				10	
Westminster	MD			7		7	
Frederick	MD	5		2		7	
Atlanta	GA	12		12		12	12
San Luis Obispo	CA			24		24	
Manhattan	KS	24				12	12
Circleville	OH						
Lancaster	OH	2		1		2	1
Canal Winchester	OH			2		2	
El Centro	CA	5		7	24	24	12
New York City	NY	6			18	18	6
Ames	IA	24	12			12	24
Defiance	OH	10			4		14
Elkridge	MD			9		9	
Laurel	MD				12		12
Elicott City	MD			3		3	
Wilkes Barre	PA	14				8	6
Conyngham	PA	10					10
Providence	UT	12					12
Logan	UT	12				12	
Sioux City	IA	12				12	
Starkville	MS	22				10	12
Greenville	TX	26				14	12
San Juan Capistrano	CA			12		12	
Dana Point	CA				12		12

*MAP = Modified atmosphere package, Other = Butcher-wrapped paper package with or without a plastic line

Table 2. Prevalence of *Salmonella* isolated from retail ground pork based on region, season, package type, and grind location.

	Model-Adjusted Prevalence (%) ¹	No. Pos./Total	P-Value	95% Confidence Interval
Region			0.07	
West	0.00	0/228		0.00 - 100.00
Central/Midwest	1.04	2/192		0.39 - 2.74
South	0.00	0/216		0.00 - 100.00
East	4.37	10/229		2.84 - 6.67
Season			0.05	
Fall	3.47	10/288		2.11 - 5.65
Winter/Spring	0.76	2/263		0.25 - 2.30
Summer	0.00	0/314		0.00 - 100.00
Package Type			0.29	
Chub	3.85	2/52		1.35 - 16.81
MAP*	2.29	4/175		0.91 - 5.64
Overwrap	1.26	6/476		0.58 - 2.60
Other*	0.00	0/162		0.00 - 100.00
Grind Location			0.17	
Case-ready	1.90	9/473		0.89 - 4.46
Store grind	0.77	3/392		0.18 - 2.91

* MAP = modified atmosphere packaging; Other = Butcher-wrapped with or without a plastic liner

¹Prevalence calculated as the number of packages from which at least one *Salmonella* isolate was recovered within its respective package level category (region, season, package type, or grind location)

Table 3. Serotypes of *Salmonella*-positive ground pork procured from U.S. retail locations

State	Package	Package Type	Season	Method	Serotype(s)
CO	Case-ready	Chub	Fall	USDA	Infantis
CO	Case-ready	Chub	Fall	USDA	Infantis
OH	Store-ground	Overwrap	Winter	USDA; FDA	4,5,12:i:-
OH	Case-ready	MAP	Winter	USDA; FDA	Brandenburg
PA	Case-ready	Overwrap	Fall	USDA	Typhimurium var 5-
PA	Case-ready	Overwrap	Fall	USDA	Typhimurium var 5-
PA	Case-ready	Overwrap	Fall	USDA	Typhimurium var 5-; Seftenberg
PA	Store-ground	Overwrap	Fall	USDA	Typhimurium var 5-
PA	Store-ground	Overwrap	Fall	USDA	Typhimurium var 5-
PA	Case-ready	MAP	Fall	FDA	Johannesburg
PA	Case-ready	MAP	Fall	USDA	Senftenberg; Johannesburg
PA	Case-ready	MAP	Fall	USDA	Johannesburg

*MAP = modified atmosphere package

Table 4. Minimum inhibitory concentrations of antibiotics needed to inhibit growth of *Salmonella* isolates from packages of retail ground pork*

ug/ml	0.015	0.03	0.06	0.12	0.25	0.5	1	2	4	8	16	32	64	128	256	512	1024
Amoxicillin/ Clavulanic Acid							21		2	14	14	8	1				
Ampicillin							0.35		0.0333	0.2333	0.2333	0.1333	0.0166				
Azithromycin							20	1	1	1	1	1	35				
Ceftoxitin							0.3333	0.0166	0.0166	0.0166	0.0166	0.0166	0.5833				
Ceftiofur								3	36	13	2	6					
Ceftriaxone								0.05	0.6	0.2167	0.333	0.1					
Chloramphenicol							17	32	8	1	0		2				
Ciprofloxacin							0.2833	0.5333	0.1333	0.0166	0.00		0.0333				
Gentamicin							1	1	15	40	2	1					
Naladixic Acid							0.0166	0.0166	0.25	0.666	0.0333	0.0166					
Streptomycin							56	4									
Sulfisoxazole							0.9333	0.0667									
Tetracycline									45	7	2	0	6				
Trimethoprim/ Sulfamethoxazole									0.75	0.117	0.0333	0.0	0.1				
	57	7	1														
	0.95	0.1167	0.0166														
							44	9	1	1		1	4				
							0.7333	0.15	0.0166	0.0166		0.0166	0.0667				
							0	26	32	2							
							0.0	0.4333	0.5333	0.0333							
									3	17	9	2	3	26			
									0.05	0.2833	0.15	0.0333	0.05	0.4333			
													4	15	1	40	
													0.0667	0.25	0.0166	0.667	
									25	3	1	4	29				
									0.4167	0.05	0.0166	0.0667	0.4833				
							53	3	1								
							0.8833	0.05	0.0166								
									1	1							
									0.0166	0.0166							

*Blue lines denote the line in which everything to the left of the line is considered susceptible to the antibiotic at that concentration.
 *Red lines denote the line in which everything to the right of the line is considered susceptible to the antibiotic at that concentration.
 *Spaces between the red and blue lines indicate intermediate resistance to the antibiotic at that concentration.

Appendix A Isolate characterization of *Salmonella* collected from ground pork at retail markets in the U.S.

H9812 Xbal 2013-03-01

H9812 Xbal 2013-03-01

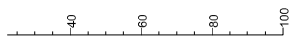

	<u>Serotype</u>	<u>State</u>	<u>Package</u>	<u>Package Type</u>	<u>Season</u>	<u>Method</u>
	Senftenberg	PA	Case-ready	Overwrap	Fall	USDA
	Senftenberg	PA	Case-ready	Overwrap	Fall	USDA
	Senftenberg	PA	Case-ready	Overwrap	Fall	USDA
	Senftenberg	PA	Case-ready	Overwrap	Fall	USDA
93.8	Senftenberg	PA	Case-ready	Overwrap	Fall	USDA
	Senftenberg	PA	Case-ready	MAP	Fall	USDA
	Senftenberg	PA	Case-ready	Overwrap	Fall	USDA
52.3	Brandenburg	OH	Case-ready	MAP	Winter	USDA; FDA
	Brandenburg	OH	Case-ready	MAP	Winter	USDA; FDA
	Brandenburg	OH	Case-ready	MAP	Winter	USDA; FDA
	Brandenburg	OH	Case-ready	MAP	Winter	USDA; FDA
	Brandenburg	OH	Case-ready	MAP	Winter	USDA; FDA
	Brandenburg	OH	Case-ready	MAP	Winter	USDA; FDA
	Brandenburg	OH	Case-ready	MAP	Winter	USDA; FDA
96.7	Brandenburg	OH	Case-ready	MAP	Winter	USDA; FDA
	Brandenburg	OH	Case-ready	MAP	Winter	USDA; FDA
	Brandenburg	OH	Case-ready	MAP	Winter	USDA; FDA
	Brandenburg	OH	Case-ready	MAP	Winter	USDA; FDA
	Brandenburg	OH	Case-ready	MAP	Winter	USDA; FDA
	Brandenburg	OH	Case-ready	MAP	Winter	USDA; FDA
	Brandenburg	OH	Case-ready	MAP	Winter	USDA; FDA
	Typhimurium var 5-	PA	Case-ready	Overwrap	Fall	USDA
	Typhimurium var 5-	PA	Case-ready	Overwrap	Fall	USDA
	Typhimurium var 5-	PA	Case-ready	Overwrap	Fall	USDA
45.0	Typhimurium var 5-	PA	Case-ready	Overwrap	Fall	USDA
	Typhimurium var 5-	PA	Case-ready	Overwrap	Fall	USDA
	Typhimurium var 5-	PA	Store-ground	Overwrap	Fall	USDA
96.9	Typhimurium var 5-	PA	Store-ground	Overwrap	Fall	USDA
	Typhimurium var 5-	PA	Case-ready	Overwrap	Fall	USDA
90.6	Typhimurium var 5-	PA	Case-ready	Overwrap	Fall	USDA
	Typhimurium var 5-	PA	Case-ready	Overwrap	Fall	USDA
85.7	Typhimurium var 5-	PA	Case-ready	Overwrap	Fall	USDA
97.6	Typhimurium var 5-	PA	Case-ready	Overwrap	Fall	USDA
71.8	Typhimurium var 5-	PA	Case-ready	Overwrap	Fall	USDA
	Typhimurium var 5-	PA	Case-ready	Overwrap	Fall	USDA
	Typhimurium var 5-	PA	Case-ready	Overwrap	Fall	USDA
	4,5,12:i:-	OH	Store-ground	Overwrap	Winter	USDA; FDA
	4,5,12:i:-	OH	Store-ground	Overwrap	Winter	USDA; FDA
	4,5,12:i:-	OH	Store-ground	Overwrap	Winter	USDA; FDA
42.8	4,5,12:i:-	OH	Store-ground	Overwrap	Winter	USDA; FDA
70.3	4,5,12:i:-	OH	Store-ground	Overwrap	Winter	USDA; FDA
	4,5,12:i:-	OH	Store-ground	Overwrap	Winter	USDA; FDA
	4,5,12:i:-	OH	Store-ground	Overwrap	Winter	USDA; FDA
	4,5,12:i:-	OH	Store-ground	Overwrap	Winter	USDA; FDA
	4,5,12:i:-	OH	Store-ground	Overwrap	Winter	USDA; FDA
	4,5,12:i:-	OH	Store-ground	Overwrap	Winter	USDA; FDA
	4,5,12:i:-	OH	Store-ground	Overwrap	Winter	USDA; FDA
	4,5,12:i:-	OH	Store-ground	Overwrap	Winter	USDA; FDA
	4,5,12:i:-	OH	Store-ground	Overwrap	Winter	USDA; FDA
	4,5,12:i:-	OH	Store-ground	Overwrap	Winter	USDA; FDA
	4,5,12:i:-	OH	Store-ground	Overwrap	Winter	USDA; FDA
	4,5,12:i:-	OH	Store-ground	Overwrap	Winter	USDA; FDA
	4,5,12:i:-	OH	Store-ground	Overwrap	Winter	USDA; FDA
	4,5,12:i:-	OH	Store-ground	Overwrap	Winter	USDA; FDA
	4,5,12:i:-	OH	Store-ground	Overwrap	Winter	USDA; FDA
37.0	Infantis	CO	Case-ready	Chub	Fall	USDA
94.6	Infantis	CO	Case-ready	Chub	Fall	USDA
	Infantis	CO	Case-ready	Chub	Fall	USDA
	Infantis	CO	Case-ready	Chub	Fall	USDA

Frequency of antibiotic resistance by phenotype isolated from retail ground pork samples in the United States¹

Serotype	Isolates (n)	Antibiotics ²										
		Amp	Aug2	Chl	Fis	Fox	Gen	Pan	Str	Sxt	Tet	Xnl
Brandenburg	12	0.17	0.17	.	0.08	.	.	0.58	0.25	.	0.25	0.08
Infantis	4	0.50	.	0.25	0.25	.
Johannesburg	5	0.20	.	.	0.20	.	0.20	0.60	0.20	0.20	0.40	.
Seftenberg	7	0.57	0.29	.	1.00	.	0.14	.	0.29	.	0.86	.
Typhimurium var 5- 4,5,12:i:-	16	0.94	0.88	0.44	0.88	.	0.13	.	0.44	.	0.56	.
	16	0.94	0.31	.	0.94	0.13	.	0.06	0.94	.	0.94	.

¹Frequency is calculated as: Frequency = number of isolates resistant to each antibiotic/total number of isolates of each serotype. The isolate was determined as resistant

²Antibiotics: Amp = Ampicillin; Aug2 = Amoxicillin/clavulanic acid 2:1 ratio; Chl = Chloramphenicol; Fis = Sulfisoxazole; Fox = Cefoxitin; Gen = Gentamicin; Pan = Pan-susceptible; Str = Streptomycin; Sxt = Trimethoprim/sulfamethoxazole; Tet = Tetracycline; Xnl - Ceftiofur

Number of antibiotic resistance by phenotype isolated from retail ground pork samples in the United States¹

Serotype	Isolates (n)	Antibiotics ¹										
		Amp	Aug2	Chl	Fis	Fox	Gen	Pan	Str	Sxt	Tet	Xnl
Brandenburg	12	7	3	-	2	2	-	3	1	1	-	-
Infantis	4	2	1	1	-	-	-	-	-	-	-	-
Johannesburg	5	3	2	1	1	-	-	1	1	-	1	-
Seftenberg	7	-	6	-	4	2	-	2	7	-	1	-
Typhimurium var 5-	16	-	9	-	15	14	-	7	14	-	2	7
4,5,12:i:-	16	1	15	-	15	5	2	15	15	-	-	-

¹Antibiotics: Amp = Ampicillin; Aug2 = Amoxicillin/clavulanic acid 2:1 ratio; Chl = Chloramphenicol; Fis = Sulfisoxazole; Fox = Cefoxitin; Gen = Gentamicin; Pan = Pan-susceptible; Str = Streptomycin; Sxt = Trimethoprim/sulfamethoxazole; Tet = Tetracycline; Xnl - Ceftiofur